

TECHNISCHE ÄNDERUNGEN VORBEHALTEN · NACHDRUCK UND KOPIEN NUR MIT UNSEREM EINVERSTÄNDNIS · Specifications subject to change without notice · Copyright ELAFLEX

GRUPPE 2 Section	GE- WICHT Weight Approx. ≈ kg	FÜR SCHLAUCHGRÖSSE For Hose Size			GEWINDE ART + GRÖSSE Thread Type + Size G	BESTELL- NUMMER Part Number Type
		ID mm	ID in.	OD mm		



0,12	13	1/2"	22	R 1/2" (BSP)	M 13 - 1/2"
0,13				R 3/4" (BSP)	M 13 - 3/4"
0,14				R 1" (BSP)	M 13 - 1"
0,13	16	5/8"	26	R 5/8" (BSP)	M 16 - 5/8"
0,14				R 3/4" (BSP)	M 16 - 3/4"
0,15				R 1" (BSP)	M 16 - 1"
0,17				M 30 x 1,5 links left	M 16 - 30 LPG
0,14	19	3/4"	27	R 3/4" (BSP)	M 19 - 3/4" LC
0,17				R 1" (BSP)	M 19 - 1" LC
0,17	19	3/4"	31	R 3/4" (BSP)	M 19 - 3/4"
0,18				R 1" (BSP)	M 19 - 1"
0,20				M 30 x 1,5 links left	M 19 - 30 LPG
0,24				R 1 1/4" (BSP)	M 19 - 1 1/4"
0,28	25	1"	34	R 1" (BSP)	M 25 - 1" LC
0,23	25	1"	37	R 1" (BSP)	M 25 - 1"
0,27				R 1 1/4" (BSP)	M 25 - 1 1/4"
0,29				R 1 1/2" (BSP)	M 25 - 1 1/2"

Mutterverschraubungen mit Schraubhülsen - Einband, geeignet zur Selbstmontage. Entsprechen DIN EN 14424 und Bundeswehnorm VG 95951. Nenndruck bis 25 bar. - Chem. Beständigkeit s. S. 250.

Hose couplings (ferrule type) with union nut (female thread), suitable for self-assembly. Working pressure up to 25 bar. Meet EN 14424. Chemical resistance chart see page 250.

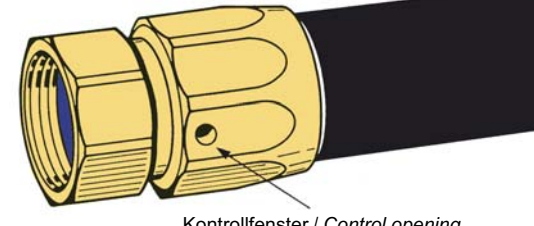

Schlauchstutzen, Hülse und Mutter aus Messing. Dichtung Polyurethan

Type M

Hose tail, union nut and ferrule of brass. Captive seal polyurethane

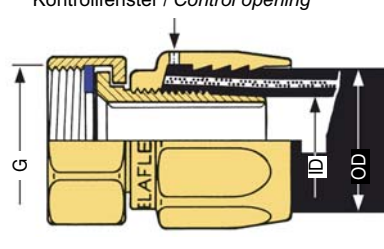

0,12	13	1/2"	22	R 1/2" (BSP)	M 13 - 1/2" cr
0,13				R 3/4" (BSP)	M 13 - 3/4" cr
0,14	16	5/8"	26	R 3/4" (BSP)	M 16 - 3/4" cr
0,15				R 1" (BSP)	M 16 - 1" cr
0,17	19	3/4"	31	R 3/4" (BSP)	M 19 - 3/4" cr
0,18				R 1" (BSP)	M 19 - 1" cr
0,20	21	7/8"	31	R 1" (BSP)	M 21 - 1" cr
0,23	25	1"	37	R 1" (BSP)	M 25 - 1" cr
0,27				R 1 1/4" (BSP)	M 25 - 1 1/4" cr

Ausführung wie Type M, jedoch Mutter und Hülse verchromt. Dichtung Polyurethan

Type M - cr

Same as Type M, but union nut and ferrule chrome plated. Captive seal polyurethane

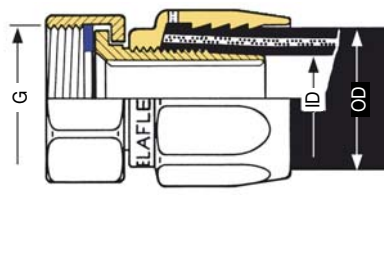

0,12	13	1/2"	22	R 1/2" (BSP)	M 13 - 1/2" SS
0,13				R 3/4" (BSP)	M 13 - 3/4" SS
0,13	16	5/8"	26	R 3/4" (BSP)	M 16 - 3/4" SS
0,14				R 1" (BSP)	M 16 - 1" SS
0,14				R 1" (BSP)	M 16 - 1" AdBlue *)
0,17				R 3/4" (BSP)	M 19 - 3/4" SS
0,18	19	3/4"	31	R 1" (BSP)	M 19 - 1" SS
0,20				R 1" (BSP)	(M 21 - 1" AdBlue *)
0,23	25	1"	37	R 1" (BSP)	M 25 - 1" SS
0,27				R 1 1/4" (BSP)	M 25 - 1 1/4" SS

Schlauchstutzen aus 1.4571. Mutter aus 1.4571 (1.4408). Hülse aus Messing verchromt. Dichtung PTFE

Type M - SS

Hose tail of stainless steel 1.4571. Union nut of 1.4571 (1.4408). Ferrule brass, chrome plated. Captive seal PTFE

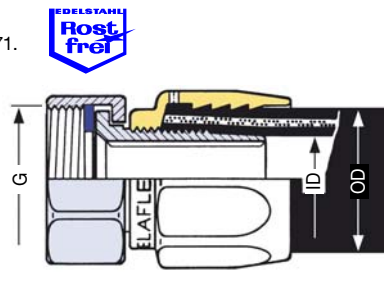

*) Stutzen SS, Mutter + Hülse Ms verchromt / Hose tail SS, union nut + ferrule brass, chrome plated					
0,15	16	5/8"	26	R 3/4" (BSP)	M 16 - 3/4" NR
0,16				R 1" (BSP)	M 16 - 1" NR
0,09	19	3/4"	31	R 1" (BSP)	M 19 - 1" NR **)
0,09	21	7/8"	31	R 1" (BSP)	M 21 - 1" NR
0,23	25	1"	37	R 1" (BSP)	M 25 - 1" NR
0,15	16	5/8"	26	R 3/4" (BSP)	M 16 - 3/4" NR cr ***)
0,16				R 1" (BSP)	M 16 - 1" NR cr ***)
0,09	19	3/4"	31	R 1" (BSP)	M 19 - 1" NR cr **)
0,09	21	7/8"	31	R 1" (BSP)	M 21 - 1" NR cr **)
0,23	25	1"	37	R 1" (BSP)	M 25 - 1" NR cr ***)

Werksmontierte Hülsen-Mutterverschraubungen, nicht demontierbar. Anschlussmaße entsprechend DIN EN 14424. Nenndruck 25 bar. Lieferung nur als komplette Schlauchleitung, da Spezialmaschine zur Montage erforderlich.

Schlauchstutzen, Mutter und Hülse Messing. Dichtung Polyurethan

Type M - NR

Hose tail, union nut and ferrule brass. Captive seal polyurethane

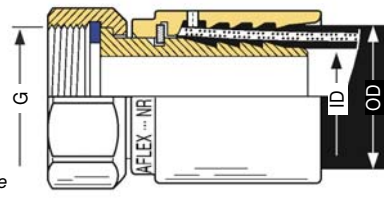

Factory assembled hose couplings ferrule type with union nut (female thread), non-reattachable. Dimensions acc. EN 14424. Working pressure up to 25 bar. Only available as complete hose assembly because a special machine is needed.

***) Mutter + Hülse verchromt / Union nut + ferrule chrome plated

Ersatzdichtungen
für Mutterverschraubungen

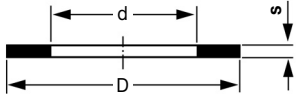

Spare Seals
for hose fittings with union nut

für for	D mm	d mm	s mm	Werkstoff Material	Bestellnummer Part Number
G 1/2"	20	13	2	Polyurethan / Polyurethane	VD 20 / 13
				PTFE	TD 20 / 13
W 21,8 x 1/14" links	22	12	2	Polyurethan / Polyurethane	VD 22 / 12
G 5/8"	23	16	2	Polyurethan / Polyurethane	VD 23 / 16
G 3/4"	26	19	2	Polyurethan / Polyurethane	VD 26 / 19
				Thermopac	HBD 26 / 19
				PTFE	TD 26 / 19
ZV 201-4 M 30 x 1,5	30	21	2	Polyurethan / Polyurethane	VD 30 / 21
G 1"	33	24	2	Polyurethan / Polyurethane	VD 33 / 24
				Thermopac	HBD 33 / 24
				PTFE	TD 33 / 24
G 1 1/4"	42	28	2	Polyurethan / Polyurethane	VD 42 / 28
				Thermopac	HBD 42 / 28
				PTFE	TD 42 / 28

Spezialdichtung **NYD** aus Polyamid, für Vaterverschraubungen mit Gewindehinterdrehung.
Wird verwendet, wenn bei flachdichtenden Gewindeverbindungen auf der Mutterseite keine sichere Abdichtung erreicht werden kann.

D	d	G	Bestellnr. Part No.
34,8	28,5	3/4"	NYD 3/4"
42,5	35,0	1"	NYD 1"

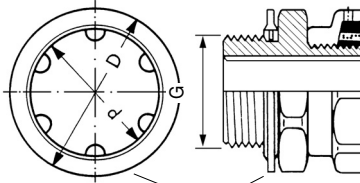

Type NYD

Special washer **NYD** of polyamide, for male threaded fittings with recess. Can be used, if no safe tightness can be achieved on the female side with flat sealing thread connections. Not suitable for NPT thread.

Sonderausführung für Schlauch LPG 10 für Flüssiggaswaagen, mit Schraubhülse einband, ganz aus Messing, mit Mutter W 21,8 x 1/14" links mit Vulkollan-Dichtung VD 22/12

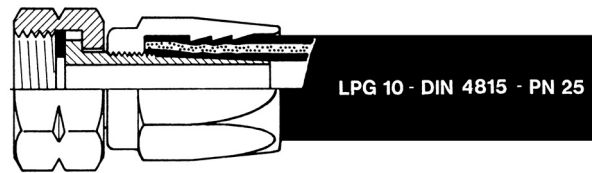

LPG 10 - DIN 4815 - PN 25

Special type for LP-gas hose LPG 10, with re-usable fitting (ferrule type) of brass, with union nut with left-hand thread W 21,8 x 1/14" left and captive seal of polyurethane

Steckschlüssel EW 15 / 25

Zur Montage von wiederverwendbaren Hülse Schlauchverschraubungen DN 16 - 25. Aus Stahl, rostgeschützt.

D 1 mm	D 2 mm	D 3 mm	D 4 mm	Bestellnummer Part Number
f. DN 16	f. DN 19	f. DN 21	f. DN 25	EW - 15/25

Box Spanner EW 15 / 25

For assembly of reusable hose fittings (ferrule type) DN 16 - DN 25. Of steel, zinc plated and chromated

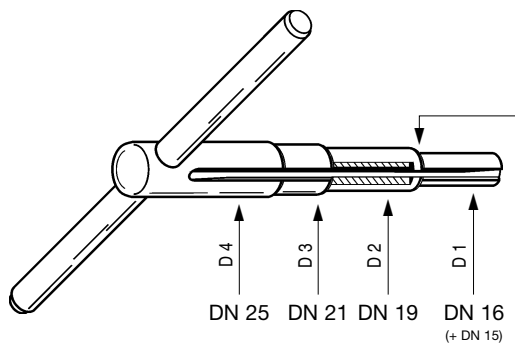

Widerhaken zum Herausziehen alter Presskonusstützen ZV 201 / 203

Barb for disassembling of old "presscone" hose fittings ZV 201 / 203

Doppelmaulschlüssel

aus Werkzeugstahl, für ZVA-Zapfventile und ELAFLEX - Schlauchverschraubungen

SW 1 mm	SW 2 mm	Bestellnummer Part Number
36	41	EW - M 36/41
41	46	EW - M 41/46

Double Head Wrench

of carbon steel. For "ZVA" nozzles and hose couplings

