

Hose Reels



HOSE REELS INSTALLATION AND OPERATING MANUAL

english

Page 2

Please read this manual carefully before installation or operation of the Hose Reels, see to additional Hose Reel markings. Be sure to follow any additional safety regulations required by local regulations or their companies. In case of doubt, please contact your service contractor or Elaflex.

DESCRIPTION

Our Hose Reels are designed for the use at terminals, road tankers, stationary or mobile refuelling. They can be built to hold hose sizes from DN 13 to 200 and any length (except length limitations for COAX hose assemblies as demanded by ATEX directive).

The Hose Reels can be configured with different rewind systems: manual rewind, spring rewind or powered rewind (hydraulic, electric, and pneumatic).

APPROVALS / OPERATING CONDITIONS

Our Hose Reels are produced to the known Elaflex high quality standard, compliant with CE regulations and meet with European health, safety and environmental standards. If requested, the Hose Reels can also comply to ATEX specifications for potentially explosive atmospheres, with suitable usage in zones 1, 2, 21 and 22. Additionally, usage is possible with gases of group IIA (e.g. propane) or group IIB (ethylene or similar) and with dust.

Make sure that the size and material of the Hose Reel and the hose with its accessories are suitable for the intended use. Take care of the pressure rating of the equipment. The operating pressure shall never exceed the nominal pressure rating.

Each Hose Reel is factory tested and labeled with the prescribed marking.

For specific operating conditions (e.g. operating pressure, operating temperature, etc.), please refer to our **HR Information sheets: elaflex.com/HoseReels**

GENERAL INFORMATION

Always use a properly rated Hose Reel, hose, Swivel Joint and accessories (e.g. nozzle/coupling) for the application.

Never exceed the working pressure rating specified for a particular Hose Reel, Swivel Joint, hose or accessories. Make sure that the size, material/fluid compatibility, temperature range, conductivity and other operation parameters of the particular Hose Reel, Swivel Joint, hose and accessories are appropriate for the intended use.

Installation must comply with the requirements of the relevant authorities and applicable country-specific regulations.

UNPACKING

After removing the package, make sure that the Hose Reel is not damaged. In case of doubt, do not use the equipment or contact a specialised centre or a dealer. The packing elements (plastic bags, foam polystyrene, nails, etc.) must not be left within the reach of children, as they are potentially dangerous. They must not be wasted in the environment, but disposed in accordance to the current regulations.

SAFETY / WARNINGS

Elaflex cannot be responsible for the final installation, as there are too many unpredictable ways to install the Hose Reel. Therefore, this responsibility lies in the hands of the installer/plant engineer. Make sure that the installer has reviewed all available information on safety, installation and maintenance provided with the equipment. Take appropriate measures to guard against pinch points.

This equipment must only be intended for the use for which it has been expressly conceived.

- **Always use caution when operating near swivel, chain or motor.**

- The parts should not be removed except for maintenance, then properly reinstalled.

- **At any time when coiled back the hose must be guided back on the reel.**

- **Keep hands away from discs when operating the hose reel. It can lead to serious injury.**

Keep the hand guiding the hose onto the Hose Reel away from the rotating drum so that there is no trapping or pinching fingers.

- **Any different use is to be considered illegitimate and thus hazardous. The manufacturer cannot be held liable for any damage resulting from illegitimate, wrong and unreasonable use.**

- Use hoses and fluids compatible with the Hose Reel and the application.

- Keep and operate the Hose Reel only within its specified fluid and ambient temperature range.

- Do not allow the equipment to be used by children.

- It is forbidden to make changes in the structure and any other part of the Hose Reel.

- The use of a proper waist-band is recommended, to which the hose end should be attached in order to avoid any accidental rewinding of the hose.

- Before any cleaning and maintenance works, disconnect the Hose Reel from the fluid supply and, if applicable, from the power supply (hydraulics, electric power, pneumatics).

- During long standstill periods disconnect the Hose Reel from the fluid supply and remove the fluid inside the hose.

For repairs, refer exclusively to an authorised dealer and request for original spare parts. Failure to fulfil the above can jeopardise the Hose Reel safety and cause the guarantee to become immediately void. During use, wear clothes pursuant to the safety regulations in force and, in any case, put on antislip rubber shoes. Proper personal protective equipment (PPE) has to be worn at every time. Avoid loose clothes, jewellery or long and loose hair.

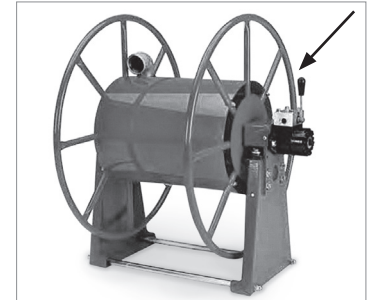

INSTALLATION OF HOSE REEL FRAME

Our Hose Reels can be mounted on plain or vertical surface without further modification. Fixing screws and accessories are not included. Choose fixing screws and accessories being able to support the weight of the equipment (multiplied by 3) but anyhow suitable to fix this type of article to wall or ceiling. Optional Swivel Supports could be also used for wall fixing.

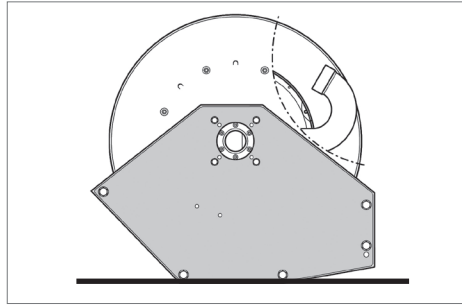

Position Plain Surface, e.g. HR CL HD 50.

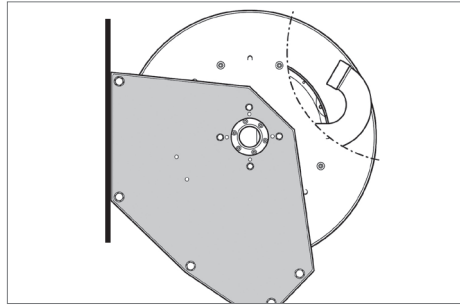

Position Vertical Surface, e.g. HR CL HD 50.

→ NOTE:

- Fix the Hose Reel in order to not interfere with any foreign bodies which could compromise its wellworking.
- The Hose Reel should be positioned far away from area with open fire.
- For grounding, identify the grounding point by the apposite adhesive and insert on the supplied screw an appropriate cable terminal with an adequate section.

INSTALLATION OF SWIVEL JOINTS

For maximum allowed working pressure, temperature ranges and forces applied to the Swivel Joint, please refer to Hose Reel information and technical specifications of products. Always use a flexible connector between Swivel Joint and inlet piping.

A misaligned hard-piped connection can add side load forces that lead to premature failure of the Swivel Joint and/or other parts of the reel.



→ **NOTE:** In order to avoid premature failure of the Swivel Joint and other parts of the equipment, load forces on the Swivel Joint shall be avoided by any means. **If the Swivel Joint is hard to rotate, please use a matching wrench to rotate it manually before putting the reel into operation.**

The Swivel Joint should be cleaned and must not show any signs of leakage or damage, such as dents, rough surfaces or sharp edges.

Besides the visual inspection, no specific maintenance is needed. Swivel Joints do not require any lubrication. Swivel Joints in unfit conditions for use must be immediately replaced.

→ **CONNECTION:** Connect the pipeline to the Swivel Joint by using a suitable flexible hose (supplied on request). It is recommended to use hoses of the same material and the same or higher diameter than the installed hose on the Hose Reel. Please also refer to the Swivel Joint operating and installation instructions supplied with the Hose Reel.

→ **TOOLS:** Use an open-end wrench with the correct wrench size to connect the hose/flexible connector to the Swivel Joint and to connect the Swivel Joint to the Hose Reel.

INSTALLATION OF SWIVEL JOINTS 90°

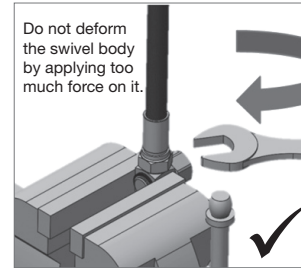
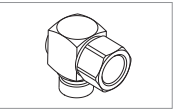

Do not deform the swivel body by applying too much force on it.

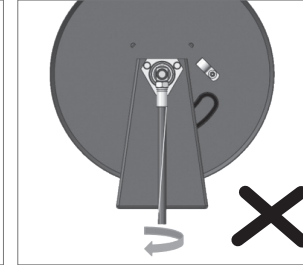
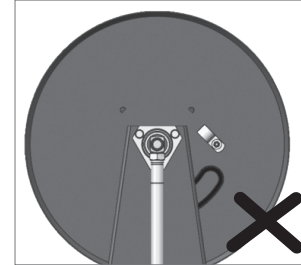
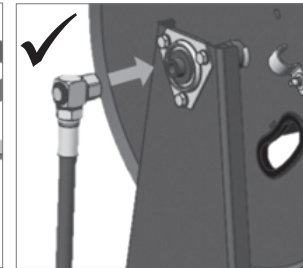

→ NOTE:

Do not use rigid pipes.

Do not twist hoses.

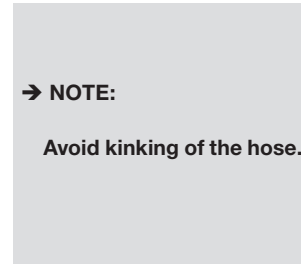

→ NOTE:

Avoid kinking of the hose.

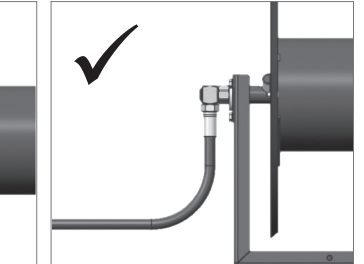
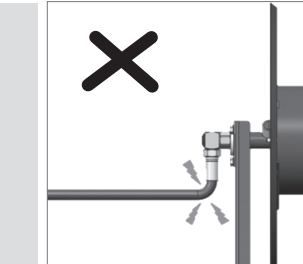

INSTALLATION OF SWIVEL JOINTS STRAIGHT

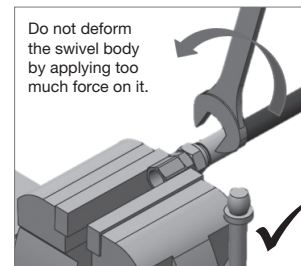
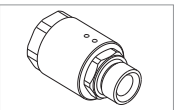

Do not deform the swivel body by applying too much force on it.

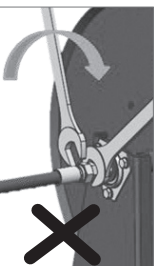
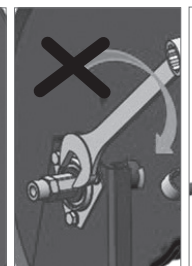
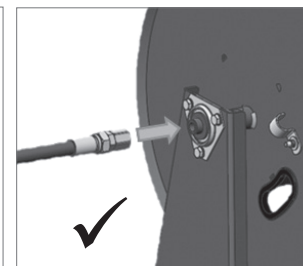

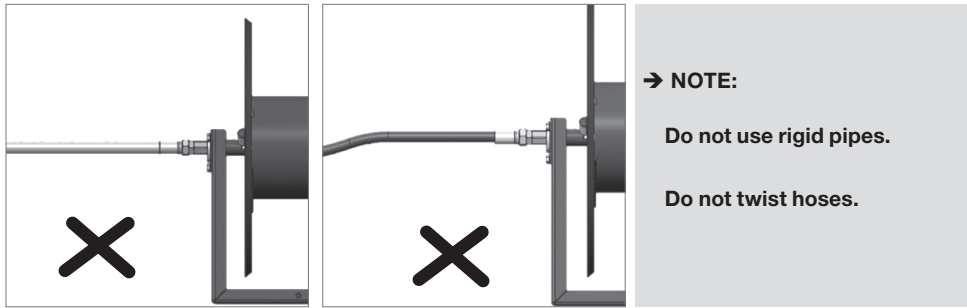

→ NOTE:
Do not use rigid pipes.
Do not twist hoses.

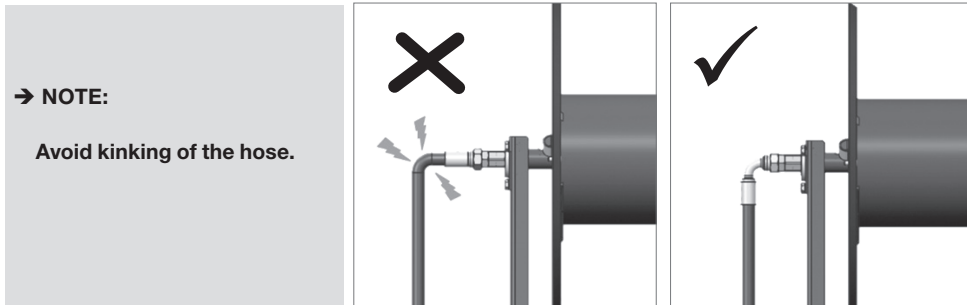

→ NOTE:
Avoid kinking of the hose.

REELING HOSES

Never reel the hose when it is cold. Hoses should be reeled at ambient temperature (i.e. ~ 20° C). The hose should lay down without any kinks and twists. Then reel the filled and pressurised hose onto the reel. Also possible to reel the hose from a second reel onto the vehicle's reel.

→ ATTENTION: Reeling hoses from a horizontal laying coil must be avoided as the hose may get kinks and twists.

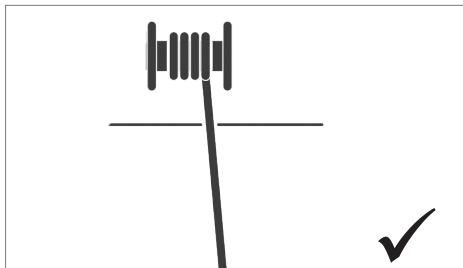

When first time reeling, hose lying straight and without kinks and twists needs to be reeled under pressurised conditions.

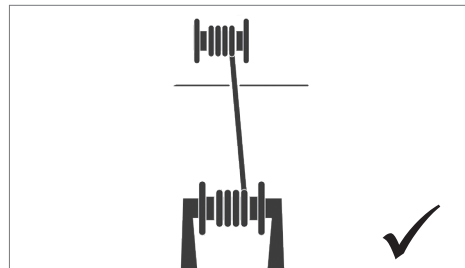

Or reel the hose from a reel onto the vehicle's reel.

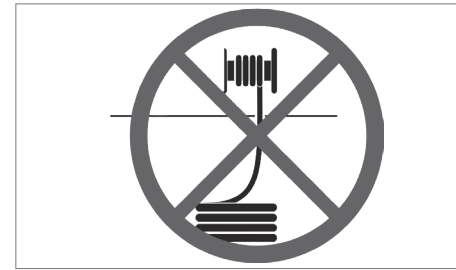

→ NOTE:
Observe the minimum bending radius – see catalogue pages.
Only use Hose Reels with core plate.
Use reels with self-breaking feature to avoid creation of loops when unreeling the hose.

→ NOTE: Test for possible leaks at fluids connections prior to putting Hose Reel into service.

HOSE INSTALLATION ON HOSE REELS

HOSE INSTALLATION ON SPRING-REWIND HOSE REELS

Always use **open-end wrenches / spanners** with the correct size to connect the hose to the Hose Reel. The sizes depend on the Hose Reel and the hose fittings. Specific information see specification sheet of each Hose Reel and the catalogue pages group 2 for coupling dimensions, respectively.

After having firmly fixed the Hose Reel, check the hose complies with the requirements resulting from the working conditions (operating pressure, temperature range, fluid compatibility, etc. see paragraphs 'Approvals / Operating Conditions' and 'General Information':



Be sure that the rewind system is completely unloaded.
(Unload the spring by rotating the reel in the opposite direction of the black arrow on the yellow sticker on the left disk.)

Keep the disks manually fixed in order to prevent uncontrolled rotation, which may cause the detachment of the spring from its support.



Remove two screws from the frame and on the opposite side of the Swivel Joint.
→ NOTE: Do not unscrew the central one, just loosen it.



Use of anti-kinking sleeve for hose size up to DN 21. Uncoil hose on the floor. Put the anti-kinking sleeve on the hose.

Insert the hose through the guide rolls.

Hose Installation for Connection Outside the Disk

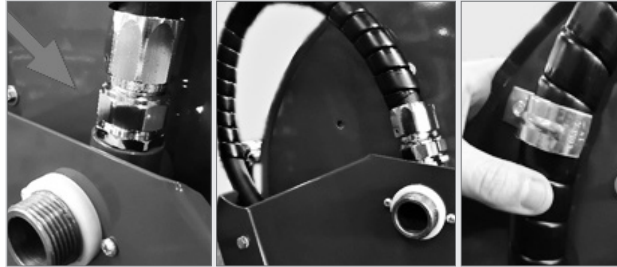

Pass hose through the disc slot. Then joint it to the shaft. Attach the double nipple into OUT connection. Then keep the hose with one hand and screw in the two screws with the other one.

Between the Disk

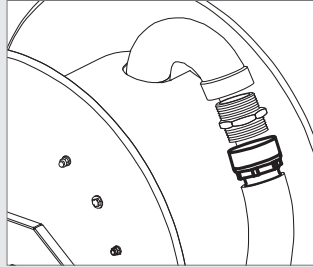

Connect the hose to the elbow by using a double nipple.

HOSE INSTALLATION WITHOUT ANTIKINKING SLEEVE OUTSIDE THE DISK

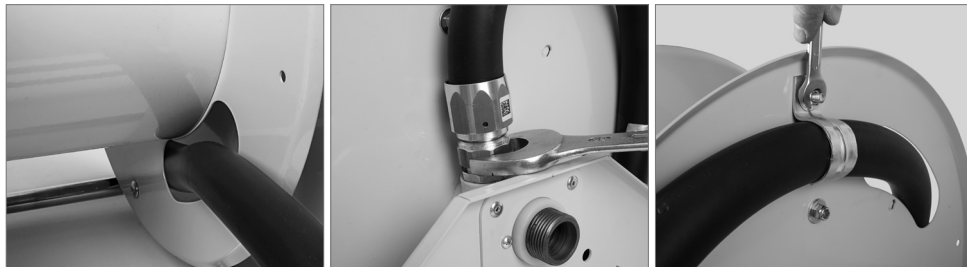

Pass hose through the disc slot. Then joint it to the shaft. Attach it onto OUT connection. Then keep the hose with one hand and screw in the two screws with the other one.

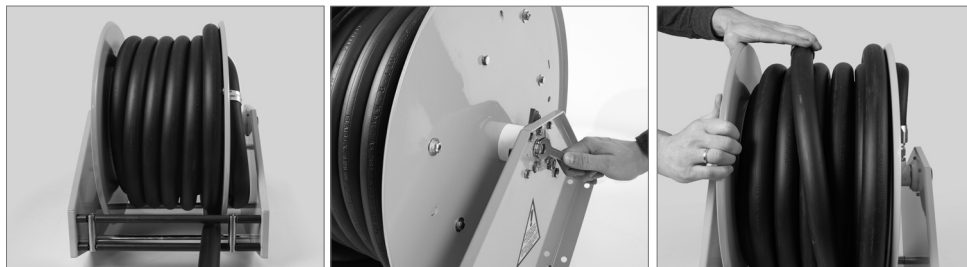

Coil the hose completely by rotating the reel manually (in the opposite direction of the arrow applied on the left disc). **Never reel the hose when it is cold.** Reel it at ambient temperature (i.e. ~ 20°C) without any kinks and twists. Reeling from a second reel onto the vehicle's reel, refer to chapter 'Reeling Hoses'.

Fix the reel with one hand when coiling is completed. With the other, screw in the two screws.

For a proper preload of the spring make one additional turn by hand of the completely coiled hose with hose end (max. 1 turn and ½) by following the direction of the arrow. **Be extremely careful.**

→ **NOTE: A higher preload does not allow the complete hose to be unwinded.**



Pass the hose end through the guide rolls and mount the Hose Stop.

Completely unroll the hose to check that it works correctly.

→ **NOTE: Never put your hands or others objets inside the reel.**

Slowly wind the hose correctly. If the hose does not wind up completely, repeat previously installation steps.

→ **NOTE:** The spring is located in a metal casing partially closed. In case of spring failure, remove the casing and replace it with a new one, as the spring cannot be repaired. **Do not open the casing itself** or force the metal casing with the purpose of repairing the spring, because this could uncoil the spring and violently hit anyone being in close proximity. This intervention shall only be done by authorised personnel.

For problems not mentioned in this manual or any fault in the equipment, you are kindly requested to ask an authorised service centre for the repair of the machine or the replacement with original spare parts. If the hose needs to be replaced, free the hose from the Hose Stop while holding the reel blocked. Follow the steps above.

HOSE INSTALLATION ON VAPOUR RECOVERY HOSE REELS

After having firmly fixed the Hose Reel, check the hose complies with the requirements resulting from the working conditions (operating pressure, temperature range, fluid compatibility, etc.), see paragraphs 'Approvals / Operating Conditions' and 'General Information':

Needed Tools:

- 1 x Box spanner 10 mm
- 1 x Ring spanner 13 mm
- 1 x Spanner DN 36 (for the double nipple)
- 1 x Specific Elaflex cylinder for bushing

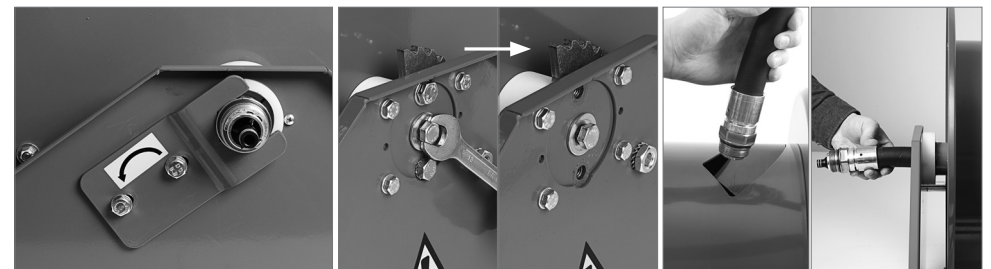

Be sure that the rewind system is completely unloaded. (Unload the spring by rotating the reel in the opposite direction of the black arrow on the yellow sticker on the left disk.) Keep the disks manually fixed in order to prevent uncontrolled rotation, which may cause the detachment of the spring from its support.

Remove two screws from the frame and on the opposite side of the Swivel Joint.

→ **NOTE: Do not unscrew the central one, just loosen it.**

Pass hose through the drum slot until the head of the hose (dispenser side) exits on the left frame side.

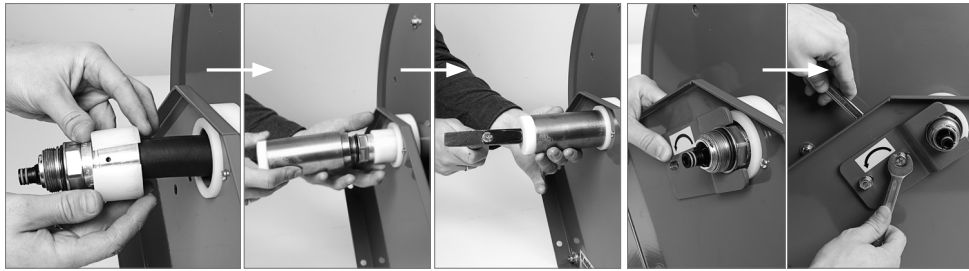

Take hose end and place the bushing around the clamping nuts.

Tap the hose end back inside the frame and assemble the fork with screws.

Please check for the correct positioning of the fitting into the fork.



Fix the hose on the right disk with specific hook using the corresponding hole.



Coil the hose completely by rotating the reel manually (in the opposite direction of the arrow applied on the left disc). **Never reel the hose when it is cold.** Reel it at ambient temperature (i.e. ~ 20° C) without any kinks and twists. Reeling from a second reel onto the vehicle's reel, refer to chapter 'Reeling Hoses'.



Fix the reel with one hand when coiling is completed. With the other, screw in the two screws.



For a proper preload of the spring make one additional turn by hand of the completely coiled hose with hose end (max. 1 turn and 1/2) by following the direction of the arrow. **Be extremely careful.**

→ **NOTE: A higher preload does not allow the complete hose to be unwinded.**



Pass the hose end through the guide rolls and mount the Hose Stop.

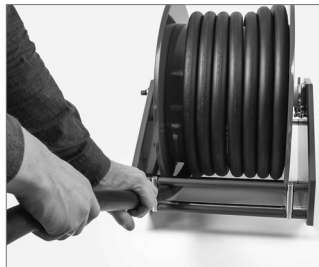

Completely unroll the hose to check that it works correctly.

→ **NOTE: Never put your hands or others objets inside the reel.**



Slowly wind the hose correctly. If the hose does not wind up completely, repeat previous installation steps.

→ **NOTE:** The spring is located in a metal casing partially closed. In case of spring failure, remove the casing and replace it with a new one, as the spring cannot be repaired. **Do not open the casing itself** or force the metal casing with the purpose of repairing the spring, because this could uncoil the spring and violently hit anyone being in close proximity. This intervention shall only be done by authorised personnel.

For problems not mentioned in this manual or any fault in the equipment, you are kindly requested to ask an authorised service centre for the repair of the machine or the replacement with original spare parts. If the hose needs to be replaced, free the hose from the hose stop while holding the reel blocked. Follow the steps above.

HOSE INSTALLATION ON MODULAR HOSE REELS (MANUAL, ELECTRIC, HYDRAULIC OR PNEUMATIC REWIND)

Always use **open-end wrenches / spanners** with the correct size to connect the hose to the Hose Reel. The sizes depend on the Hose Reel and the hose fittings. Specific information see specification sheet of each Hose Reel and the catalogue pages group 2 for coupling dimensions, respectively.

After having firmly fixed the Hose Reel, check the hose complies with the requirements resulting from the working conditions (operating pressure, temperature range, fluid compatibility, etc. see paragraphs 'Approvals / Operating Conditions' and 'General Information':



Use of anti-kinking sleeve for hose size up to DN 21. Uncoil hose on the floor. Put the anti-kinking sleeve on the hose.

Insert the hose through the guide rolls.

Hose Installation for Connection Outside the Disk



Pass hose through the disc slot. Then joint it to the shaft. Attach the double nipple into OUT connection. Then keep the hose with one hand and screw in the two screws with the other one.

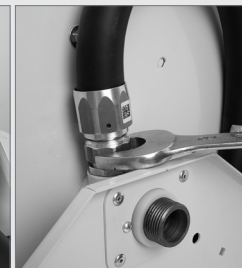

Between the Disk

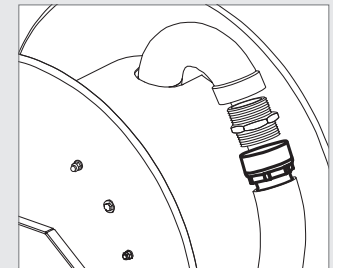

Connect the hose to the elbow by using a double nipple.

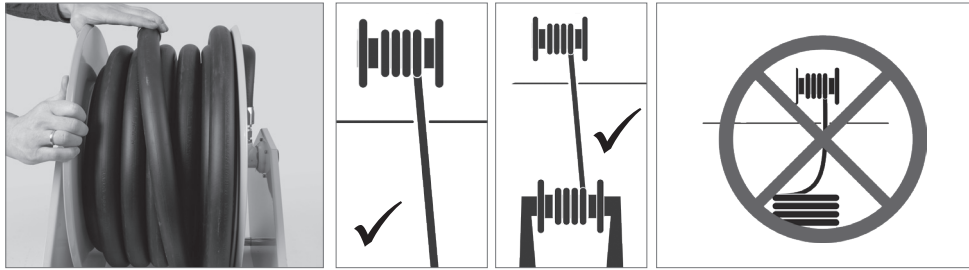

Coil the hose completely by rotating the reel manually or with help of the motor (in the opposite direction to the arrow applied to the left disc).
Operating instructions see 'Use of Different Rewind Systems'.

Before reeling, read carefully. Never reel the hose when it is cold. Hoses should be reeled at ambient temperature (i.e. ~ 20°C). The hose should lay down without any kinks and twists. Also possible to reel the hose from a second reel onto the vehicle's reel.



Pass the hose end through the guide rolls and mount the Hose Stop.

Completely unroll the hose to check that it works correctly.
→ **NOTE: Never put your hands or others objects inside the reel.**

Slowly wind the hose correctly. If the hose does not wind up completely, repeat previous installation steps.

→ **NOTE:** In case of any problems not mentioned in this manual or any fault in the equipment, please contact an authorised service centre for the repair of the machine or the replacement with original spare parts.

If the hose needs to be replaced, free the hose from the hose stop while holding the reel blocked. Follow the steps above.

HINTS FOR ELAFLEX HOSE ASSEMBLIES AND NOZZLES

If the Hose Reel is equipped with Elaflex hoses, please follow the handling instructions on **Catalogue Page 106** and the **operation instructions of hose assemblies**.

→ **NOTE:** Only use Elaflex couplings and nozzles suitable for Hose Reels.
In case of doubt, please contact our Elaflex sales team.

OPERATING OF HOSE REELS

→ **NOTE:** Never put hands or fingers in the Hose Reel or its side disks during winding or unwinding operation. Ensure the Hose Reel is mounted firmly before taking it into operation.

When using a Swivel Joint

- Always avoid side load forces on the Swivel Joint by installing a flexible connection to the Swivel Joint instead of a rigid pipe.
- Rigid pipes could lead to mechanical damages or leakage of the Swivel Joint and other mechanical parts of the Hose Reel.
- During operation of the Hose Reel avoid movements that could lead to kinking or torsion of the flexible connection to the Swivel Joint, e.g. if the Hose Reel is installed on a rotatable base plate.

When using a Hose Stop

- Designed to be larger than the opening between the hose guide roller bars, if the hose is not used in operation under constant tension or secured in the uncoiled position in any other way.
- Prevents couplings or nozzles assembled on the hose from being damaged.
- Be aware to always guide the hose back on the Hose Reel in a smooth and controlled way.

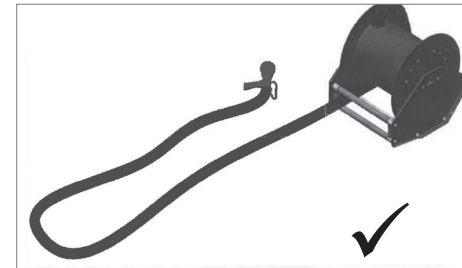

Before packaging, fold the hose in half as shown. Begin the wrapping phase always accompanying the hose during its positioning.

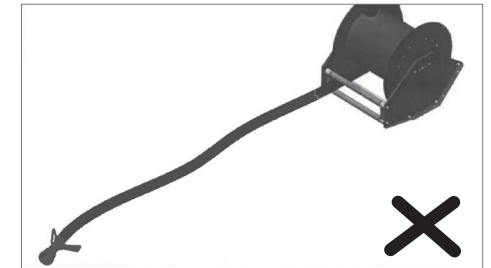

Avoid releasing the grip on the hose in the previous step to prevent the hose from coming back abruptly.

USE OF DIFFERENT REWIND SYSTEMS

Each rewind system has different operating requirements, see overview.

SPRING REWIND

- spring-loaded system for retraction of hoses
- reinforced and also usable under rough conditions

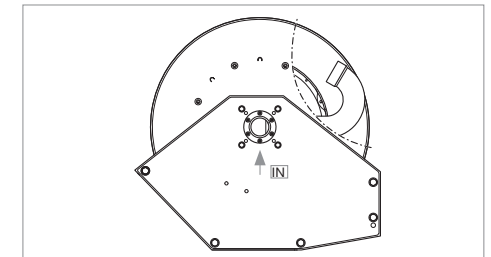

MANUAL REWIND (1)

- with lateral handle and if required a brake
- direct drive

HYDRAULIC REWIND (2)

- hydraulic motor with operational levers and hydraulic lock
- direct drive

THREE PHASE ELECTRIC REWIND (3)

- electric motor 230/400V
- direct drive
- on request: ATEX 2GD or 3GD

ELECTRIC REWIND (4)

- electric motor 12V or 24V
- direct drive
- on request: ATEX 2GD or 3GD

PNEUMATIC REWIND (5)

- pneumatic motor
- direct drive

ACCESSORIES

Hose Guide Kit (6)

Automativ Hose Guide Kit (7)

Kit for Disc Closure (8)

Hints for use, see HR Information online.

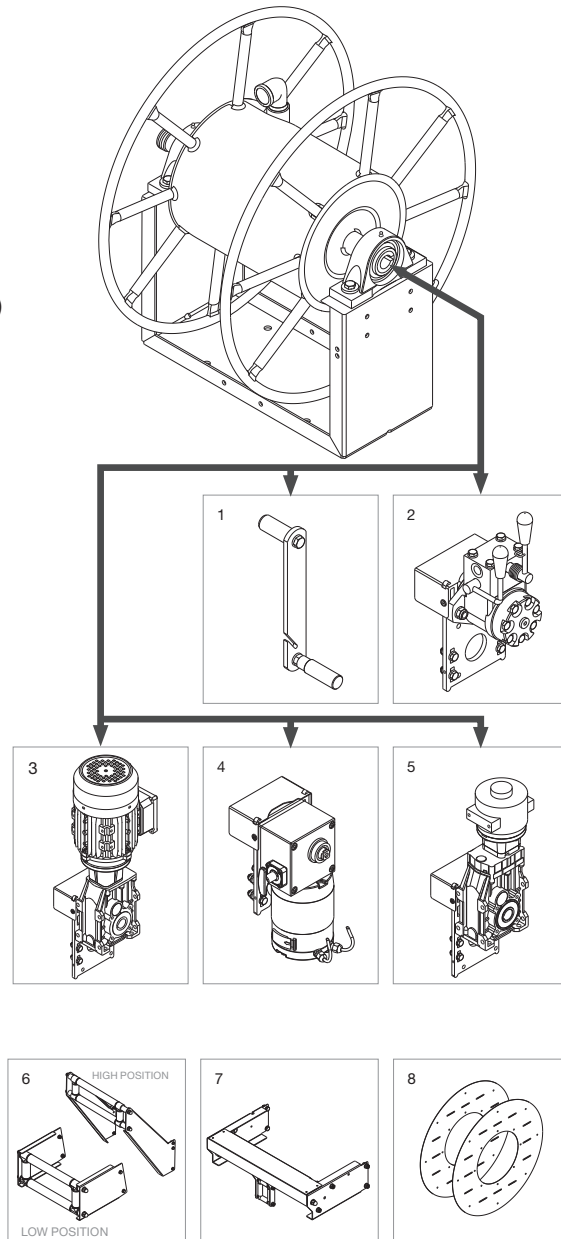

USE OF SPRING REWIND SYSTEMS

Be cautious when the Hose Reel latch assembly lock is disengaged.

→ **NOTE:** When unlocking the latch, ensure that you have a firm hold on the hose and that the hose is guided on the reel when the reel rewinds the hose.

OPERATING

For **unwinding** the hose pull the hose to uncoil it from the reel. When releasing the pull force, assure that the reel brake will fix the Hose Reel in the wanted position.

To **rewind** the hose, give the hose a short pull and the hose will be coiled on the reel by means of the tensioned spring.

Because of the strong rewinding force of the spring, make sure to have a firm grip on the hose in order to avoid uncontrolled and quick rewinding of the hose onto the Hose Reel. Otherwise the lose end of the hose or its accessories could endanger or even hit the operator by uncontrolled movement.

Uncontrolled quick rewinding might also damage the interior and exterior mechanical parts of the Hose Reel. The hose guide ensures a well-aligned hose on every single layer during the rewinding process. That enables the hose to move easily and with low handling force for the operator when unwind the next time.

MAINTENANCE / TROUBLESHOOTING

• Never let the hose be rewinded in an uncontrolled manner.

→ Hose must be guided back on the reel when coiled at any time. If the hose accidentally rewinds itself without any guidance, damage to the Hose Reel or personal injury could happen.

• Never open the frame and remove the spring.

→ The coiled spring is under high tension and removing the frame could lead to severe injuries. If the spring rewind mechanism is damaged, it shall always be replaced by trained personnel.

Before any intervention on the equipment, check that the spring is released. A periodical check should be carried out at least every 100 working hours on the following:

- The spring tension
- The wear and tear of the lock system (ratchet and cogwheel)
- The joints and the wear and tear of the hose
- The screws which fix the Hose Reel to the supporting frame
- Correct sealing and absence of leakages
- Correct grounding of the machine
- Periodically remove deposits of dust

→ **ATTENTION:** If the hose needs to be replaced, follow the steps in the paragraphs above treating the installation of the hoses.

USE OF MANUAL REWIND SYSTEM (1)

For **unwinding** the hose pull the hose to uncoil it from the reel. Uncontrolled quick rewinding must be avoided to prevent a high momentum and uncontrolled stopping behavior of the Hose Reel.

Use the Hose Reel block when the uncoiling is done to prevent uncontrolled movements from the Hose Reel during operation.

For **rewinding** ensure a well-aligned hose on every single layer during the rewinding process. A hose guide facilitates this action. A well-aligned hose enables the hose to move easily and with low handling force for the operator when unwind the next time.

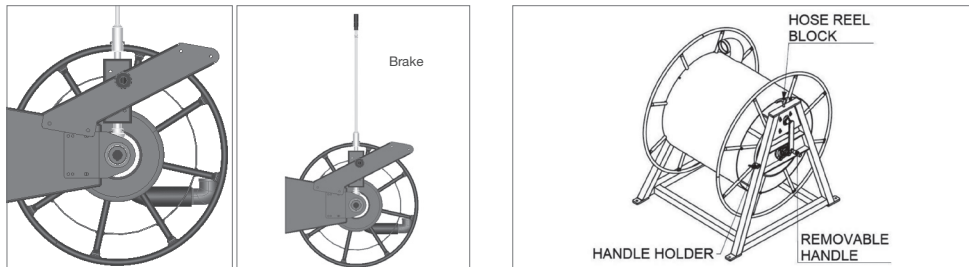

Frontal crank with mechanical brake

Removable lateral handle

MAINTENANCE / TROUBLESHOOTING

• Never let the hose be rewinded in an uncontrolled manner.

→ Hose must be guided back on the reel when coiled at any time. If the hose accidentally rewinds itself without any guidance, damage to the Hose Reel or personal injury could happen.

Before effecting any intervention on the equipment, check that the spring is released. A periodical check should be carried out at least every 100 working hours on the following:

- The spring tension
- The wear and tear of the lock system (ratchet and cogwheel)
- The joints and the wear and tear of the hose
- The screws which fix the Hose Reel to the supporting frame
- Correct sealing and absence of leakages
- Correct grounding of the machine
- Periodically remove deposits of dust

→ **ATTENTION:** If the hose needs to be replaced, follow the steps in the paragraphs above treating the installation of the hoses.

USE OF HYDRAULIC REWIND SYSTEM (2)

OPERATING

Before **unwinding** the hose make sure the hose is free to move, without any knots or obstacles along the hose where it might be trapped and not in a dangerous position to potentially harm the staff around.

For unwinding and winding the hose use the lever of the speed control kit as indicated. For unwinding the hose manually, keep the lever up.

Uncontrolled quick rewinding must be avoided to prevent a high momentum and uncontrolled stopping behavior from the Hose Reel. When having the hydro-stop kit, keep its lever in the upper position to block the Hose Reel when the uncoiling is done to prevent uncontrolled movements from the Hose Reel during operation.

For **rewinding** ensure a well-aligned hose on every single layer during the rewinding process. A hose guide facilitates this action. A well-aligned hose enables the hose to move easily and with low handling force for the operator when unwind the next time.

CONNECTIONS

Check all hydraulic connection for proper installation prior to use.

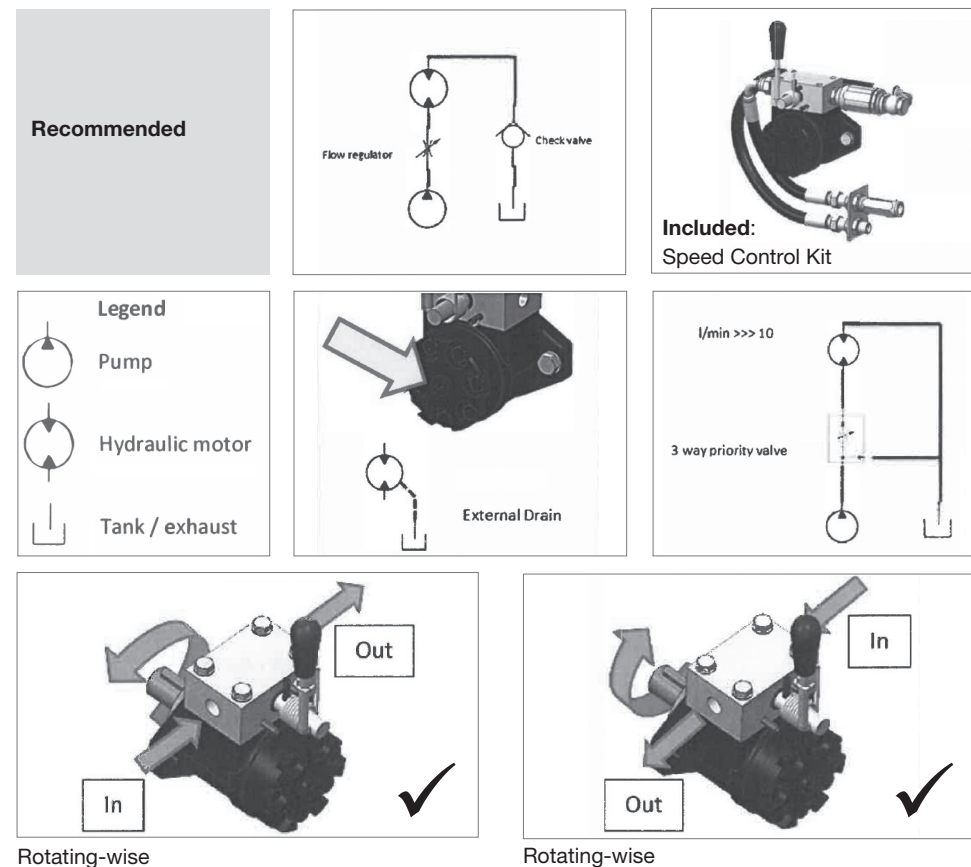

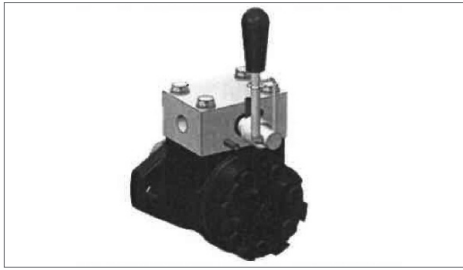

Lever up: idle reel, manual unwind – **even with circuit under pressure.**



Lever down: rewinding

ACCESSORIES



Optional:

Hydro-stop kit
(Reel stop / Normal operation)

MAINTENANCE / TROUBLESHOOTING

• Never let the hose be rewinded in an uncontrolled manner.

→ Hose must be guided back on the reel when coiled at any time. If the hose accidentally rewinds itself without any guidance, damage to the Hose Reel or personal injury could happen.

Before effecting any intervention on the equipment, check that the motor is disconnected from the hydraulic supply. A periodical check should be carried out at least every 100 working hours on the following:

- The functioning and tightness of the motor and hydraulic supply
- The joints and the wear and tear of the hose
- The wear and tear of the hydraulic hoses
- The screws which keep fixed the Hose Reel to the supporting frame
- Correct sealing and absence of leakages
- Correct grounding of the machine
- Periodically remove deposits of dust

→ **ATTENTION:** If the hose needs to be replaced, follow the steps in the paragraphs above treating the installation of the hoses.

USE OF THREE PHASE ELECTRIC REWIND SYSTEM (3)

Check all electrical connections for proper installation prior to use.

→ **NOTE:** Before wiring any motor, verify the motor voltage listed on the motor tag matches the supply voltage. Be sure to follow all local electrical code requirements. If you are unsure about electrical requirements, consult a qualified electrician.

OPERATING

Before unwinding the hose make sure the hose is free to move, without any knots or obstacles along the hose where it might be trapped and not in a dangerous position to potentially harm the staff around.

For unwinding and winding the hose use the corresponding buttons as indicated. For unwinding the hose manually, you can simply pull the hose and not use the control buttons at all.

Uncontrolled quick rewinding must be avoided to prevent a high momentum and uncontrolled stopping behavior from the Hose Reel.

Prevent uncontrolled movements from the Hose Reel during operation.

Rewinding: ensure a well-aligned hose on every single layer during the rewinding process. A hose guide facilitates this action. A well-aligned hose enables the hose to move easily and with low handling force for the operator when unwind the next time.

MAINTENANCE / TROUBLESHOOTING

• Never let the hose rewind itself uncontrolled.

→ Hose must be guided back on the reel when coiled at any time. If the hose accidentally rewinds itself without any guidance, damage to the Hose Reel or personal injury could happen.

Before effecting any intervention on the equipment, check that the motor is disconnected from the power supply. A periodical check should be carried out at least every 100 working hours on the following:

- The functioning of the motor
- The proper connection of the electric cables
- The joints and the wear and tear of the hose
- The screws which keep fixed the Hose Reel to the supporting frame
- Correct sealing and absence of leakages
- Correct grounding of the machine
- Periodically remove deposits of dust

→ **ATTENTION:** If the hose needs to be replaced, follow the steps in the paragraphs above treating the installation of the hoses.



→ WARNING:

Avoid contact with water.

If wet, wait for drying before use.

USE OF ELECTRIC REWIND SYSTEM WITH 12 OR 24 V MOTOR (4)

Check all electrical connections for proper installation prior to use.

→ **NOTE:** Before wiring any motor, verify the motor voltage listed on the motor tag matches the supply voltage. Be sure to follow all local electrical code requirements. If you are unsure about electrical requirements, consult a qualified electrician.

TECHNICAL SPECIFICATIONS

Motor: 12 V 30/60 rpm	Motor: 24 V 30 rpm
400 W	400 W
43 A	20 A
IP 54	IP 54

OPERATING

Before **unwinding** the hose make sure the hose is free to move, without any knots or obstacles along the hose where it might be trapped and not in a dangerous position to potentially harm the staff around.

For unwinding and winding the hose use the corresponding buttons as indicated. For unwinding the hose manually, you can simply pull the hose and not use the control buttons at all.

Uncontrolled quick rewinding must be avoided to prevent a high momentum and uncontrolled stopping behavior of the Hose Reel.

Prevent uncontrolled movements from the Hose Reel during operation.

For **rewinding** ensure a well-aligned hose on every single layer during the rewinding process. A hose guide facilitates this action. A well-aligned hose enables the hose to move easily and with low handling force for the operator when unwind the next time.

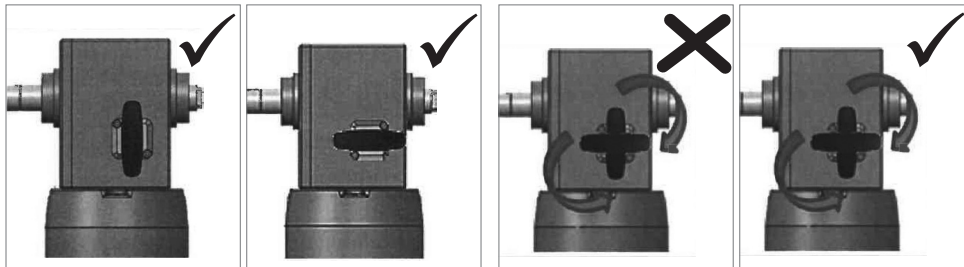

Gear engaged.
Motor OFF / Reel stopp
Motor ON / Rewind

Neutral gear.
Motor ON or OFF
Idle reel / manual unwind

Motor ON / Reel moving Motor OFF / Reel stopp

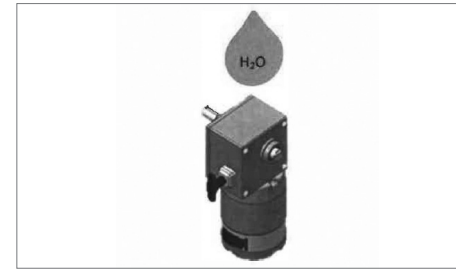

→ **WARNING:**
Avoid contact with water.
If wet, wait for drying before use.

CABLE CONNECTIONS

→ **ATTENTION:** For wiring, use cables with an appropriate length and cross-section.

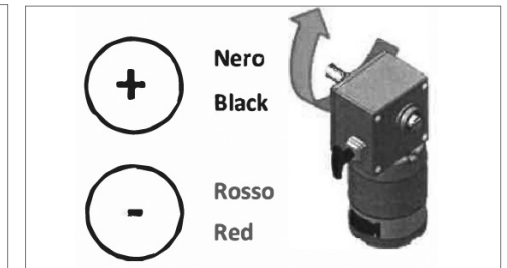
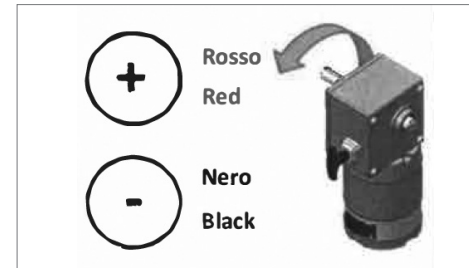

ACCESSORIES



Recommended:
ON/OFF Kit 12/24 V
(included)

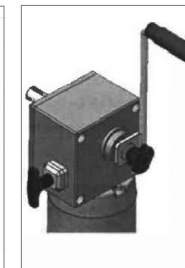
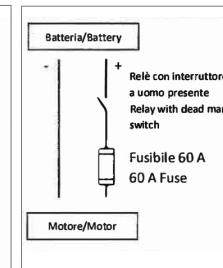

Optional:
Emergency
crank kit

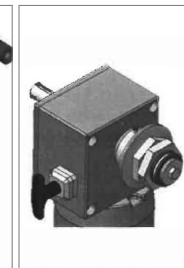

Clutch kit for
braked unwinding

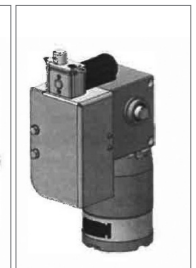

Electromechanical
coupling kit

MAINTENANCE / TROUBLESHOOTING

• **Never let the hose rewind itself uncontrolled.**

→ Hose must be guided back on the reel when coiled at any time. If the hose accidentally rewinds itself without any guidance, damage to the Hose Reel or personal injury could happen.

Before effecting any intervention on the equipment, check that the motor is disconnected from the power supply. A periodical check should be carried out at least every 100 working hours on the following:

- The functioning of the motor
- The proper connection of the electric cables
- The joints and the wear and tear of the hose
- The screws which keep fixed the Hose Reel to the supporting frame
- Correct sealing and absence of leakages
- Correct grounding of the machine
- Periodically remove deposits of dust

→ **ATTENTION:** If the hose needs to be replaced, follow the steps in the paragraphs above treating the installation of the hoses.

USE OF PNEUMATIC REWIND SYSTEM (5)

Always depressurise the pneumatic system before installation or maintenance. Check all connections for proper installation prior to use.

→ **NOTE:** Do not exceed the maximum allowable supply pressure of the pneumatic motor given in its manual or on the motor tag.

OPERATING

Before **unwinding** the hose make sure the hose is free to move, without any knots or obstacles along the hose where it might be trapped and not in a dangerous position to potentially harm the staff around.

For unwinding and winding the hose use the corresponding buttons as indicated. For unwinding the hose manually, you can simply pull the hose and not use the control buttons at all.

Uncontrolled quick rewinding must be avoided to prevent a high momentum and uncontrolled stopping behavior from the Hose Reel.

Prevent uncontrolled movements from the Hose Reel during operation.

For **rewinding** ensure a well-aligned hose on every single layer during the rewinding process. A hose guide facilitates this action. A well-aligned hose enables the hose to move easily and with low handling force for the operator when unwind the next time.

MAINTENANCE / TROUBLESHOOTING

• **Never let the hose rewind itself uncontrolled.**

→ Hose must be guided back on the reel when coiled at any time. If the hose accidentally rewinds itself without any guidance, damage to the Hose Reel or personal injury could happen.

Before effecting any intervention on the equipment, check that the motor is disconnected from the power supply. A periodical check should be carried out at least every 100 working hours on the following:

- The functioning of the pneumatic motor
- The proper connection of the pneumatic hose assemblies
- The joints and the wear and tear of the hose
- The screws which keep fixed the Hose Reel to the supporting frame

- Correct sealing and absence of leakages
- Correct grounding of the machine
- Periodically remove deposits of dust

→ **ATTENTION:** If the hose needs to be replaced, follow the steps in the paragraphs above treating the installation of the hoses.

CONDITIONS OF USE

Failure to comply with any warnings, instructions, procedures or any other common sense procedures may result in injury, equipment damage, property damage or poor performance of the equipment.

Elaflex Hiby accepts no liability for direct, indirect, incidental, special, or consequential damages resulting from failure to follow any warnings, instructions and procedures in this manual, or any other common sense procedures generally applicable to equipment of this type. The foregoing limitation extends to damages to person or property caused by the unit or damages resulting from the inability to use the unit including loss of profits, loss of products, loss of power supply, the cost of arranging an alternative power supply, and loss of time, whether incurred by the user or their employees, the installer, the commissioner, a service technician, or any third party.

The manufacturer reserves the right to change the specifications of its products or the information in this manual without necessarily notifying its users.

Variations in installation and operating conditions may affect the unit's performance. Elaflex Hiby has no control over each installation's unique operating environment. Hence, no representations or warranties concerning the performance of the unit under the actual operating conditions prevailing at the installation are made. A technical expert of your choosing should validate all operating parameters for each application.

Elaflex Hiby has made every effort to explain all servicing procedures, warnings, and safety precautions as clearly and completely as possible. However, due to the range of operating environments, it is not possible to anticipate every issue that may arise. This manual is intended to provide general guidance. For specific guidance and technical support, contact your authorised supplier or specialist service contractor.

Only approved original parts shall be used and no unauthorized modifications to the hardware shall be made. The use of non-approved parts or modifications will void all warranties and approvals. The use of non-approved parts or modifications may also constitute a safety hazard.

Information in this manual shall not be deemed a warranty, representation, or guarantee. For warranty provisions applicable to this unit, please refer to the warranty provided by the supplier.

Every effort has been made to ensure the accuracy of this document. However, it may contain technical inaccuracies or typographical errors. Elaflex Hiby assumes no responsibility for and disclaims all liability of such inaccuracies, errors or emissions in this.

WARRANTY

Elaflex Hiby guarantees against defective materials and manufacturing for 12 months from date of supply. If the delivery date cannot be established, the production date applies. The production date is marked on the Hose Reel body.

Excluded are subjected to wear and tear and damages caused by improper use, for example the use with unsuitable media. Furthermore excluded are indirect damages and costs, such as travelling related to exchange and repair work. We refuse any liability for consequential loss or damage resulting from the use of our Hose Reels.

